

Rise Ticker Hardware Install Guide (Flexible / Curved Tickers)



www.RiseDisplay.com

Version 1.4 (update 09/16/24)

Table of Contents

Tools Required	1
Technical Specifications	1
Network Settings	2
ETL Certification	2
Wall Mount	3
Ceiling Mount (option A) - 1/2" NPT threaded rod	5
Ceiling Mount (option b) - Eyehook + aircraft cable	7
Connecting Sections	7
Installing Corners	9
Twin Ticker	10
Network Connectivity	10
Troubleshooting	12

Tools Required

- Cordless drill with phillips bit #1 & #2
- Standard set of drill bits
- 3/8" nut driver
- Torpedo Level
- Chalk line (or a laser level if possible)
- Tape measure

Technical Specifications

- [32 Pixel \(4mm\)](#)
- [48 Pixel \(4mm\)](#)
- [64 Pixel \(4mm\)](#)

Network Settings

The LED ticker's IoT controller communicates with our Cloud platform via both inbound and outbound TCP/IP connection to **cms.risedisplay.com** via **TCP Port 9090**. In order for the ticker to properly function, please make sure you whitelist this URL and port number on your network firewall. If you are unable to whitelist the domain [cms.risedisplay.com](https://docs.aws.amazon.com/vpc/latest/userguide/aws-ip-ranges.html), you will need to whitelist the IP address range for the AWS region "US East 1" located at

<https://docs.aws.amazon.com/vpc/latest/userguide/aws-ip-ranges.html>

ETL Certification



This document supersedes all previous Authorizations to Mark for the noted Report Number.

This Authorization to Mark is for the exclusive use of Intertek's Client and is provided pursuant to the Certification agreement between Intertek and its Client. Intertek's responsibility and liability are limited to the terms and conditions of the agreement. Intertek assumes no liability to any party, other than to the Client in accordance with the agreement, for any loss, expense or damage occasioned by the use of this Authorization to Mark. Only the Client is authorized to permit copying or distribution of this Authorization to Mark and then only in its entirety. Use of Intertek's Certification mark is restricted to the conditions laid out in the agreement and in this Authorization to Mark. Any further use of the Intertek name for the sale or advertisement of the tested material, product or service must first be approved in writing by Intertek. Initial Factory Assessments and Follow up Services are for the purpose of assuring appropriate usage of the Certification mark in accordance with the agreement, they are not for the purposes of production quality control and do not relieve the Client of their obligations in this respect.

Intertek Testing Services NA Inc.
545 East Algonquin Road, Arlington Heights, IL 60005
Telephone 800-345-3851 or 847-439-5667 Fax 312-283-1672

Standard(s):	Audio/Video, Information and Communication Technology Equipment - Part 1: Safety Requirements [UL 62368-1:2019 Ed.3] Audio/Video, Information and Communication Technology Equipment - Part 1: Safety Requirements [CSA C22.2#62368-1:2019 Ed.3]
Product:	RGB sign

Wall Mount

1. Flex tickers are mounted directly to the wall (no wall brackets) using the pre-drilled holes in the chassis.

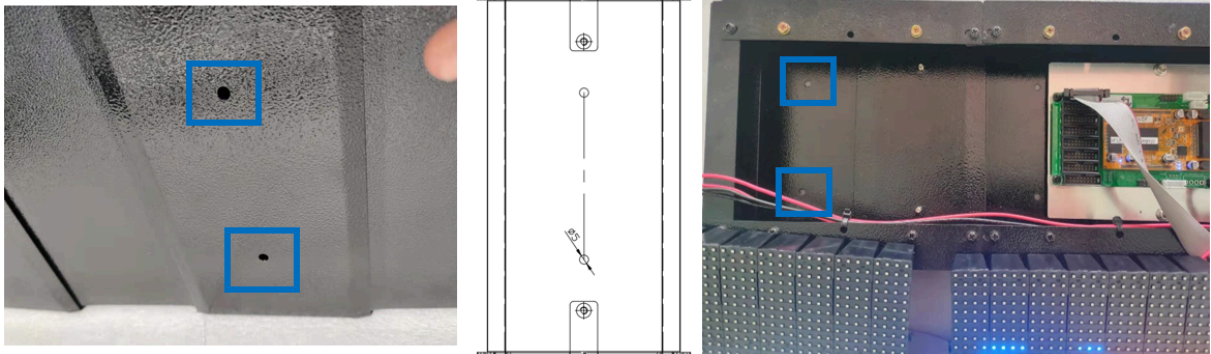

2. Remove LED panels (magnetic) as needed to drill through the back of the chassis into wall studs (or use Anchors/drywall plugs) using a minimum of two-inch screws. Working right to left starting with Section A1.
3. Once the section has been securely fastened to the wall, reinstall the LED panels to the front of the chassis (magnetic).
4. Repeat for all remaining sections, connecting subsequent chassis sections together.

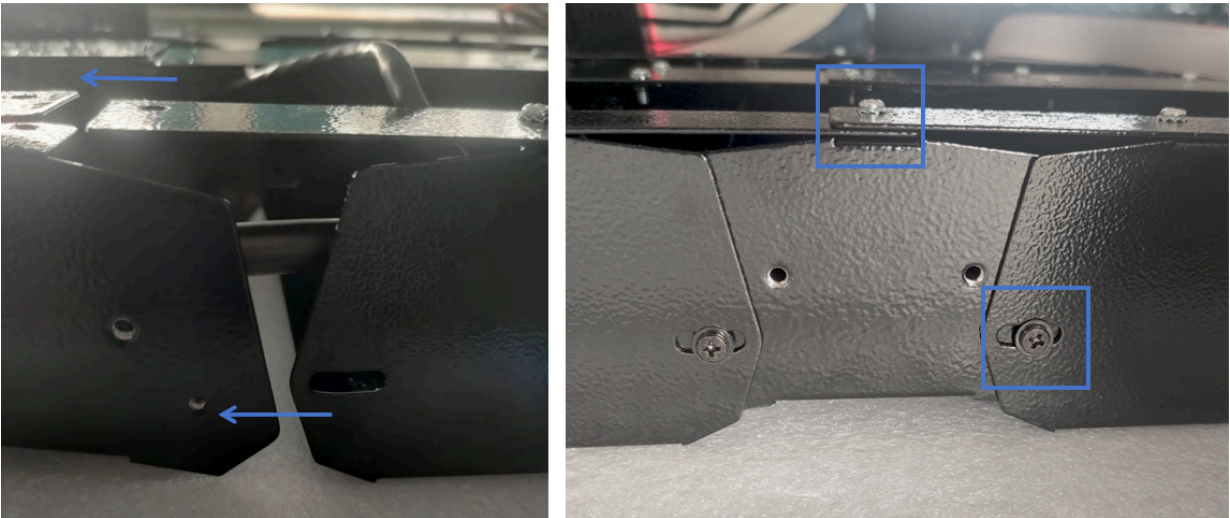

5. If the ticker is a wall-mounted in a complete circle, check the drawing to see if there is a planned gap between the rear of the chassis and the wall in order to close the circle. If so, make it within the allowance of the length of the mounting screws.

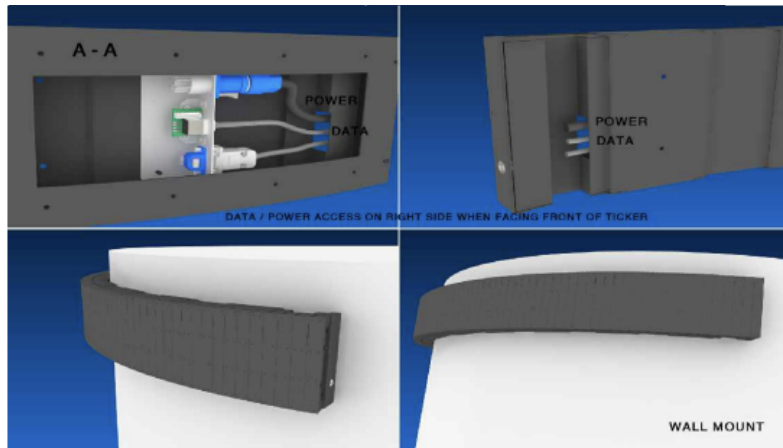
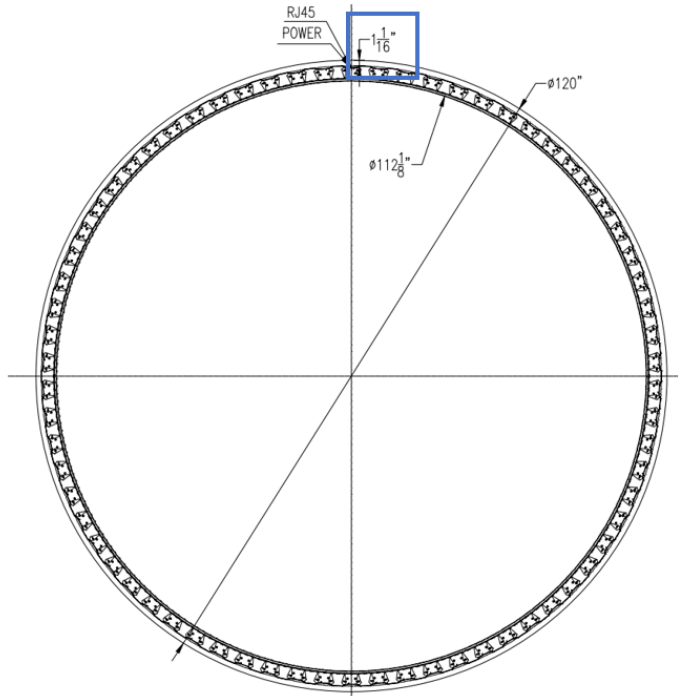



Ceiling Mount (option A) - 1/2" NPT threaded rod

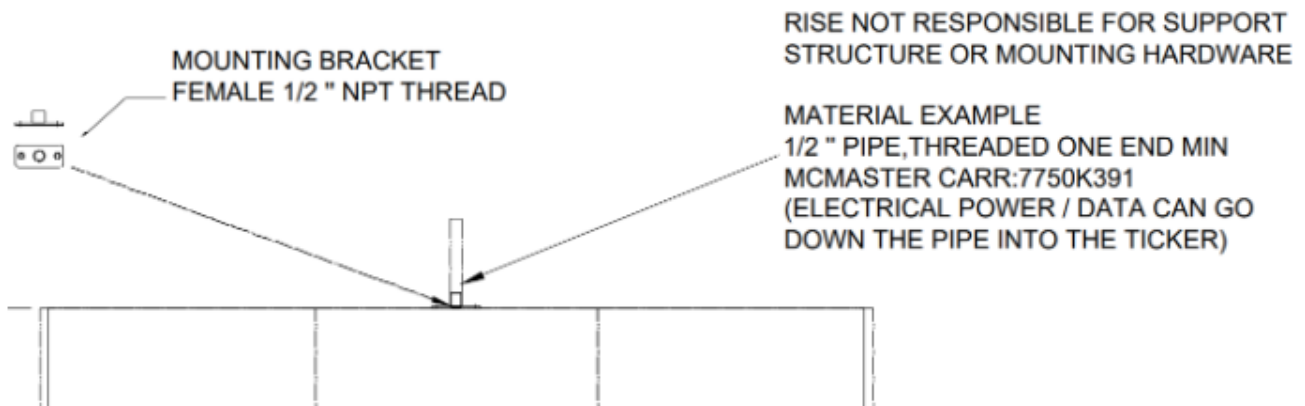

1. Loosely thread the 1/2" NPT female adapter (shown below) onto the 1/2" NPT support (male), do not fully tighten. NPT support not included.

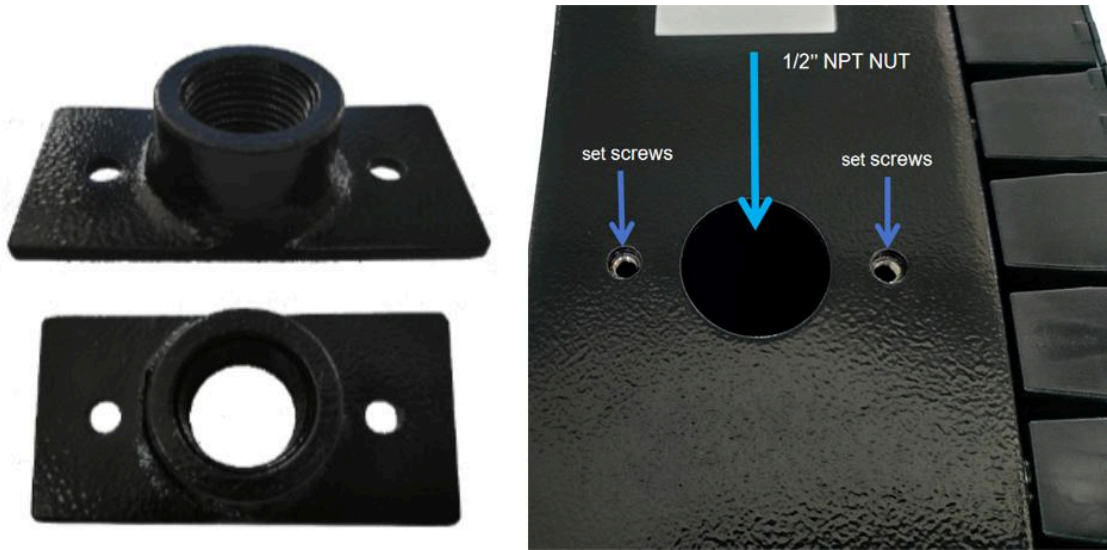

2. Lift the ticker section and connect tighten the adapter to the top of the ticker using the set screws.
3. Repeat for each of the support points for that section.
4. Repeat for all sections of ticker.(connection plate to join sections, if it's a full circle, make sure the transition line's section is installed in the right location)



Ceiling Mount (option b) - Eyehook + aircraft cable



1. Attach a chain or aircraft cable to the eyehook on top of the ticker cabinets.
2. Repeat for each of the support points for that section.
3. Repeat for each section of the ticker.

Connecting Sections

1. Align all sign sections as diagrammed below. A1 is the primary/main section with the controller and WIFI data receiver. It should be positioned at the far right, starting point.

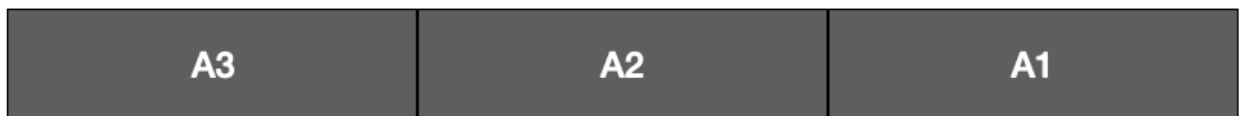

2. Remove the module on both ends of each section. The modules are attached by magnets.

3. Connect the RJ45 data cable between sections (A1 & A2, A2 & A3, etc.)

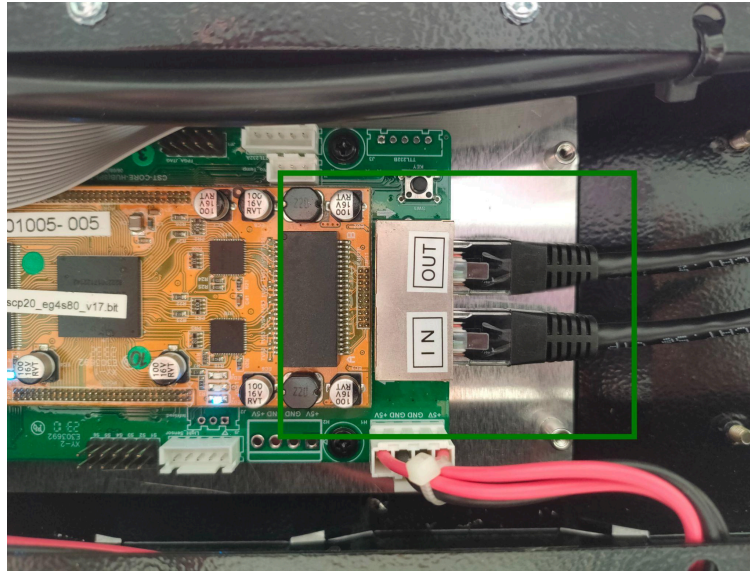

4. Connect the power connection between sections (A1 & A2, A2 & A3, etc.)

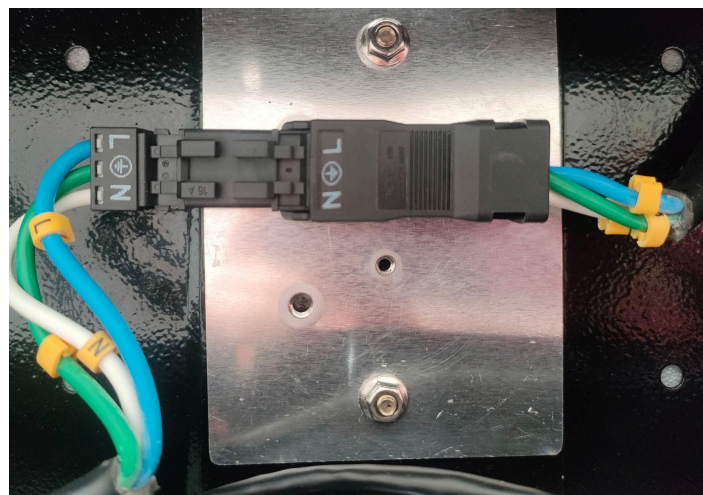
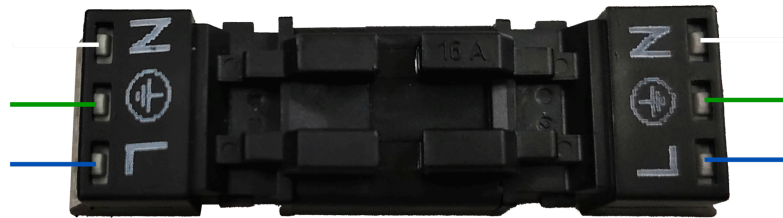

5. Repeat the above steps until all sections are connected.
6. Plug the AC power cable and ethernet network cable (unless ticker will use wifi) into the port inside of the right side of A1. Once the power cable is plugged in the right direction, it will be locked in place.

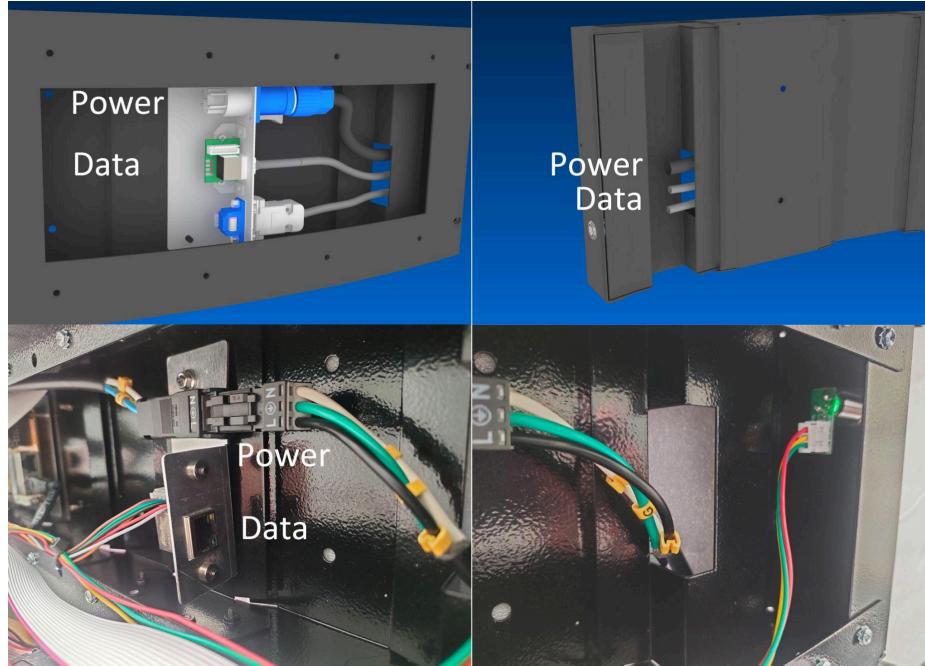

7. The pre-loaded message should start at section A1 and scroll continuously across the entire sign from right to left. If the message doesn't properly scroll through all sections check the data and power cable connections between sections (steps 3 and 4 above).

Installing Corners

If your ticker has corners:

1. Place the two segments together and connect the data cable and power cables between the two segments. (see steps 2-4 in Connecting Sections).
2. Rotate the joining metal to the desired angle and slide in the slot, tighten the screws to fix the two segments together in the determined degree.

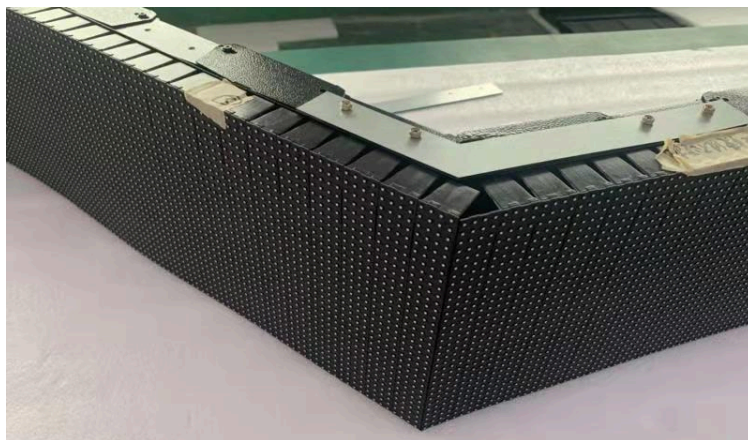

Twin Ticker

Twin Tickers (2 separate streams) must be defined at the time of purchase so the displays are properly built with a 2nd controller and 2nd mobile app subscription. (i.e. this can not be changed after installation). **BOTH RJ45 JACKS MUST BE CONNECTED TO THE INTERNET VIA ETHERNET CABLES ON TWIN TICKERS! (if connecting via wifi, both "TickerT" or "TickerTop" AND "TickerB" or "TickerBottom" must be connected to the site wifi network).**

Network Connectivity

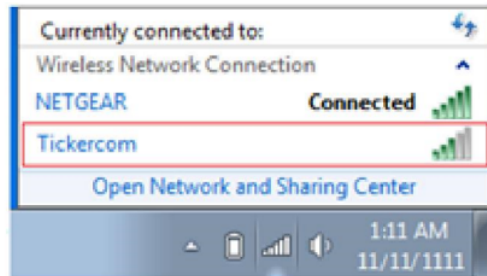

1. If you are using a wired connection, plug your Cat5 cable to the RJ45 port (see photo in step 7 on the previous page). If you ordered a twin ticker, there will be one RJ45 port on the right side and one on the left side.
2. For a wireless connection, once the sign is turned on with either a Smartphone or PC/Laptop that can detect wireless networks, follow these steps:
 - a. Check available wireless networks, locate and connect to the network named 'Ticker' the password for this network is '**PASSWORD**' all in upper case. Once Connected to 'Ticker' your device may state that you have 'Limited Connectivity' this is normal. If it says "Unable to join the network", please try the WIFI setup on a different device.



- b. Once connected to 'Ticker' open your browser and in the address bar type in 192.168.0.1 and press enter.
- c. A pop-up screen will appear requesting a login Username and Password. Enter the following and click Sign in.
Username: admin
Password: PASSWORD
- d. From the ticker sign's wireless setup screen interface select the "QuickConnect" option from the left hand menu to view all available wireless networks.

WLAN Link Scan

Network name:

Network Name	BSSID	Ch	RSSI	Security Suite
<u>SKYBOX</u>	8E:79:67:A9:24:D5	11	 -37 dBm dBm	WPA2-CCMP
Kidsroom	50:D2:F5:F1:DF:A0	3	 -67 dBm dBm	WPA2-CCMP- TKIP
office	80:3F:5D:FC:18:66	1	 -71 dBm dBm	WPA2-CCMP

- e. Select the desired wireless network and enter the associated password and click submit.

Security

Key Type:	<input checked="" type="radio"/> Passphrase <input type="radio"/> Hex
Password:	<input style="width: 100%;" type="password" value="••••••"/>

▶ Advanced

- f. After you see the confirmation screen your ticker has successfully connected and you can exit your browser.

```

Changed WLAN Profile New_Profile Instance to "SKYBOX".
Changed WLAN Profile New_Profile Basic Network Name to "SKYBOX".
Changed WLAN Profile New_Profile Security Suite to "WPA2".
Changed WLAN Profile New_Profile Security WPAX Passphrase to "
<Configured>".
Changed WLAN Profile New_Profile Security WPAX Encryption to
"CCMP".
The changes have been saved permanently.
```

3. Ensure your network / firewall is set up to allow Outbound TCP/IP communication to **cms.risedisplay.com** via port **9090**. More details check out the [Rise Ticker App User Guide](#).
4. To update your content and control the scroll speed and brightness by downloading the Rise Ticker App from the Apple App Store or Google Play Store.
5. If you have a Twin Ticker you will need to replicate these steps for the 2nd controller.

Troubleshooting

- No content is appearing on your ticker - make sure the power cable is firmly connected.
 - If there is a white blinking LED in the top right of section A1, this means your ticker is in power save mode. Use the remote or Rise Ticker mobile app to turn off power save and resume scrolling content.
- Content is only scrolling on a portion of the ticker - it is likely that something wasn't connected properly during installation or something came loose in shipping. Start by removing the section to the left of the last working section. Disconnect and reconnect the power cable and the CAT5 jumper.
- My ticker data is not updating - unplug your ticker for 2 minutes then reconnect power and wait 60 seconds to see if the content updates. Then check your Rise Ticker App to see if the ticker shows online, if it is showing red go to a device connected to the same network and type 192.168.0.1 in the address bar and log in with Username: admin Password: PASSWORD. Navigate to the Interface wlan0 menu item and see if the Connection State is "Connected". If it says disconnected repeat the step 2 under Network Connectivity from this guide.
 - If your ticker is equipped with an external controller power button, make sure it is illuminated green. NOTE: older ticker models may have a brightness button here instead.
Photo of power button:



- If your ticker is not properly updating and you have verified it is connected, share the [Rise Ticker App User Guide](#) with your IT department and have them check your organization firewall to ensure it is not blocking connectivity to the ticker.
- If you have any other questions or need assistance email us at support@risedisplay.com.